SURE-STOP® PVC WATERSTOP

HIGH PERFORMANCE MATERIAL SPECIFICATION

PRODUCT DESCRIPTION

CORKJOINT Sure-Stop PVC Waterstops lead the way in high technology waterstops and comply to international standards.

Sure-Stop PVC Waterstops are extruded from specially compounded PVC in accordance with BS2571. They are designed for use in water retaining and water excluding structures where a positive seal is required for poured in-situ concrete expansion, construction and contraction joints.

The range of profiles for both centrally and externally placed applications when embedded into the concrete, form a continuous barrier making Sure-Stop PVC Waterstops ideal for preventing water penetration.

These profiles are available in rolls with separate intersections supplied to simplify and minimise on-site fabrication.

Concrete structures are only as watertight as the waterstops that join them. Sure-Stop Waterstops are designed to allow for expansion, contraction and other movements that can cause joints to open and close.

The efficiency of any waterstop is very dependent on good workmanship and on full compaction of the surrounding concrete. Optimum performance will be achieved if the waterstop is installed by keeping these factors in mind.

ADVANTAGES

- A full range of profiles and sizes to suit all construction requirements
- Sure-Stop PVC Waterstops conform to and exceed all major international standards
- High quality compounded PVC for long durability and integrity
- Factory made intersections to simplify and minimise on-site fabrication
- On-site welding equipment is available upon request
- Internal profiles come with factory pre-punched eyelets for easy and secure wire tying to reinforcement
- Ability to withstand high hydrostatic head pressures

AREAS OF APPLICATION

Water retaining structures:

- Water tanks
- Bund walls
- Sewage treatment plants
- Reservoirs
- Dams and spillways
- Water treatment plants
- Swimming pools

Water excluding structures:

- Basement areas
- Underground car parks
- Tunnels
- Retaining walls
- Suspended slabs
- Below ground slabs
- Roof slabs

TECHNICAL FEATURES

COLOUR	Orange
PACKAGING	150mm - 200mm = 20m / Roll, 250mm = 15m / Roll, 320mm = 12m / Roll
ROLL WEIGHT	Dependent upon profile
STORAGE CONDITIONS/SHELF LIFE	5 years from the date of production if stored properly in original, unopened and undamaged sealed packaging in dry conditions out of direct sunlight at temperatures between +10°C and +40°C
MATERIAL TYPE	Polyvinyl Chloride
WELDING TEMPERATURES	Approximately 180°C-200°C
SERVICE TEMPERATURE RANGE	-15°C to +70°C

PHYSICAL PROPERTIES - HIGH PERFORMANCE MATERIAL

PROPERTY	TEST METHOD	REQUIREMENT
Tensile Strength (MPa)	BS2782:320A	>15
Elongation at Break (%)	BS2782:320A	>350
Water Absorbtion at 32°C	BS 2782:430A	<1% by weight
Specific Gravity (g/cm ³)	BS2782:620B	1.27 (+/-0.3)
Hardness, Shore A	BS2782:365B	75 +/-5

NOTE: Refer to Corkjoint's in-house Certificate of Analysis (COA) for test results pertaining to the above. Internal COA's are conducted on every batch of raw material that is used in the production of Sure-Stop PVC waterstops. Independent laboratory test results are also available upon request.

PROFILE WIDTH SELECTION

The width of waterstop depends on the thickness of the concrete and positioning of the reinforcement. The thickness of the concrete should be greater than or equal to the width of the waterstop profile. Refer to CORKJOINT for further information.

SITE JOINING

CORKJOINT recommends the use of its specialized welding equipment for on-site welding which consists of thermostatically-controlled welding blades and special welding jigs (each type of CORKJOINT Sure-Stop PVC Waterstop requires its own welding jig to suit the particular shape). On-site joining is a simple exercise using CORKJOINT Heat Welding Equipment comprising of an adjustable welding jig and heating blade. The ends of the waterstop are cut square and placed into the adjustable jig. The ends of the waterstop then slide up against the heating blade and bring the two ends together until the molten ends of the PVC fuse. When ordering welding equipment, please advise profile number of waterstop required.

HEALTH & SAFETY: Joining of PVC Waterstops is performed by heat welding which results in the discharge of hydrogen chloride mist and vapour. In confined spaces or in still air conditions, the use of a ventilation fan or a suitable respirator should be adopted.

WRITTEN SPECIFICATIONS

Where shown on the drawings all PVC waterstops shall be Sure-Stop (State profile number required) as supplied by CORKJOINT. Provide factory made waterstop fabrications for all changes of direction, intersections and transitions leaving only straight butt joined splices for on-site fabrication.



INTERNATIONAL PROFILE RANGE

FOR EXPANSION JOINTS

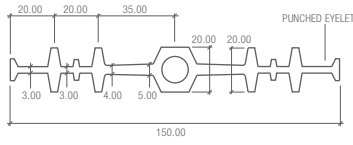

CJ 951

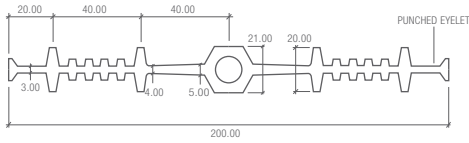

CJ 952

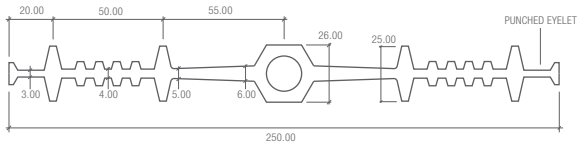

CJ 953

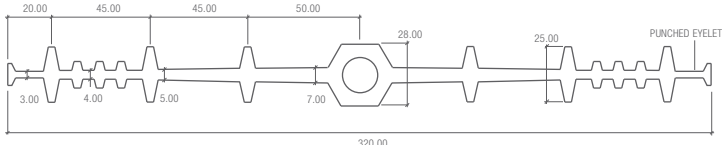

CJ 954

FOR CONSTRUCTION JOINTS

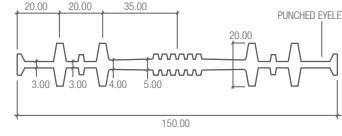

CJ 955

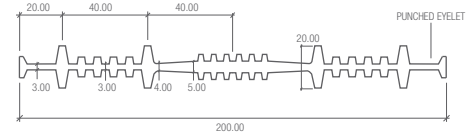

CJ 956

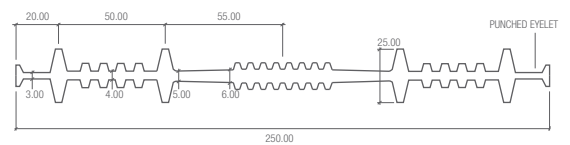

CJ 957

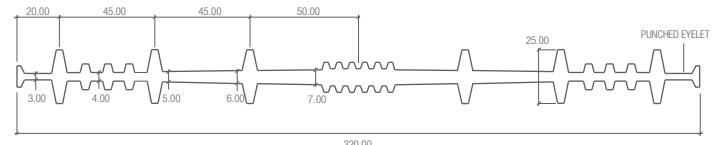

CJ 958

NOTE: Full dimension drawings available upon request

FOR EXPANSION JOINTS

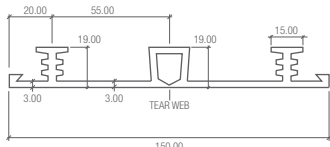

CJ 923

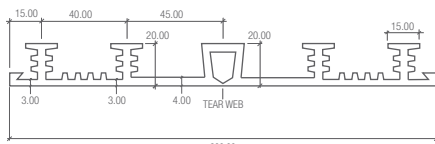

CJ 924

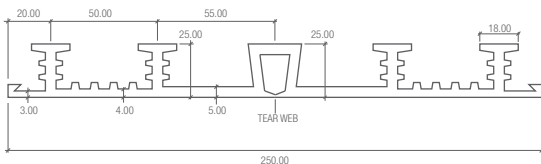

CJ 925

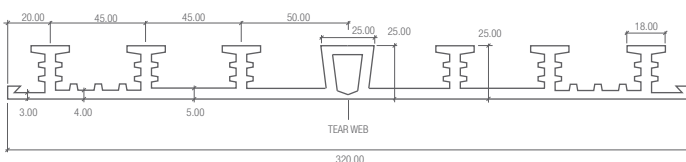

CJ 926

FOR CONSTRUCTION JOINTS

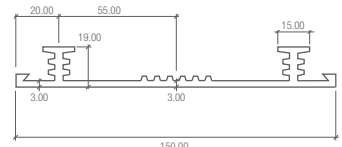

CJ 927

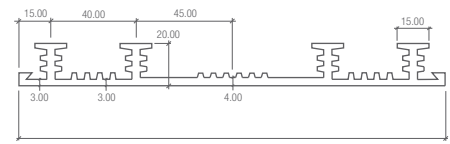

CJ 928

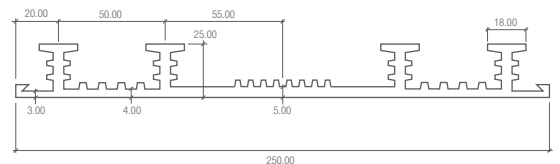

CJ 929

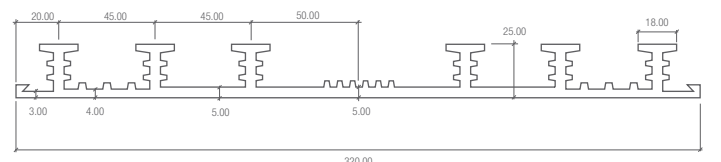

CJ 930

TYPICAL APPLICATIONS

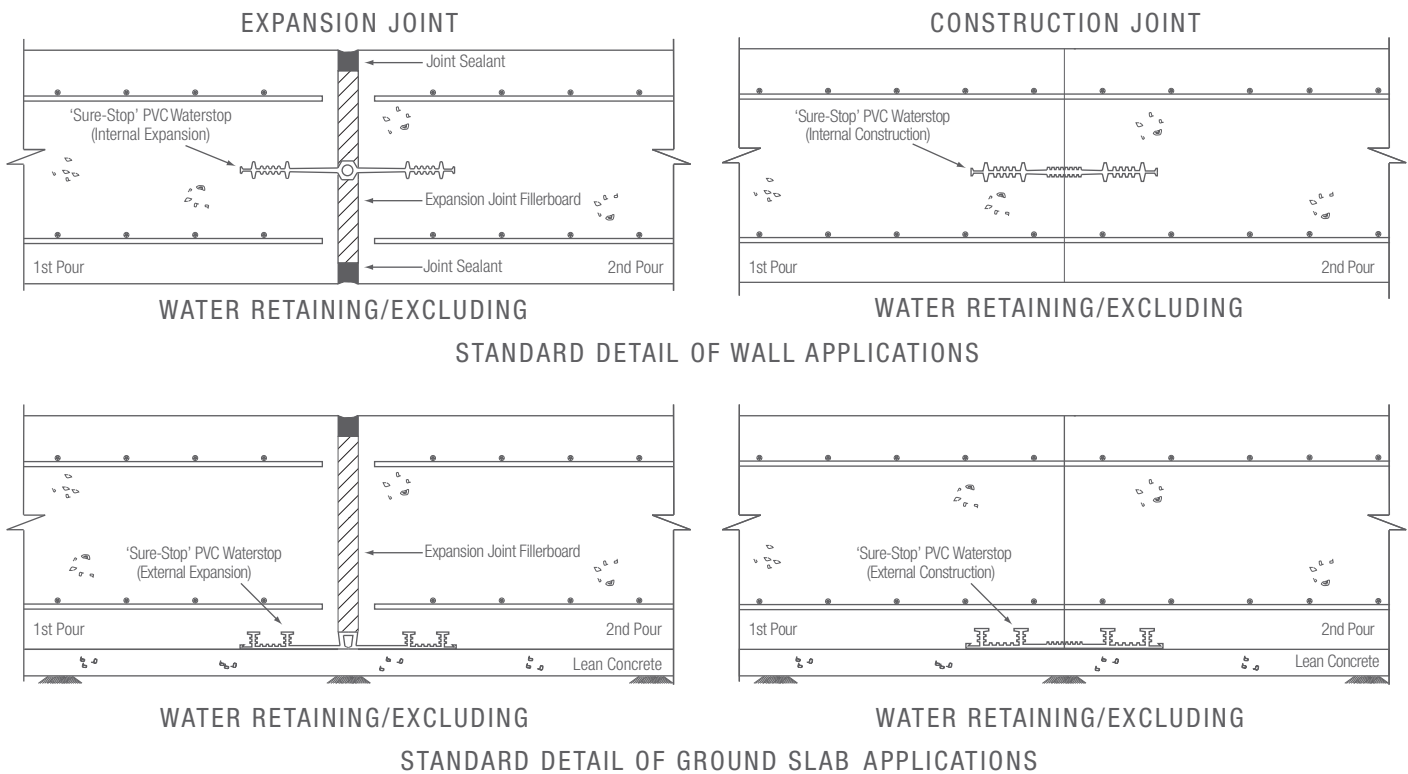

FACTORY - MADE INTERSECTIONS

A wide range of standardized prefabricated intersection pieces are available allowing easy site welding of butt joints to Sure-Stop PVC Waterstop junction pieces. Customised pieces can be made to suit. In such cases, drawings must be provided giving exact dimensions and jointing details.

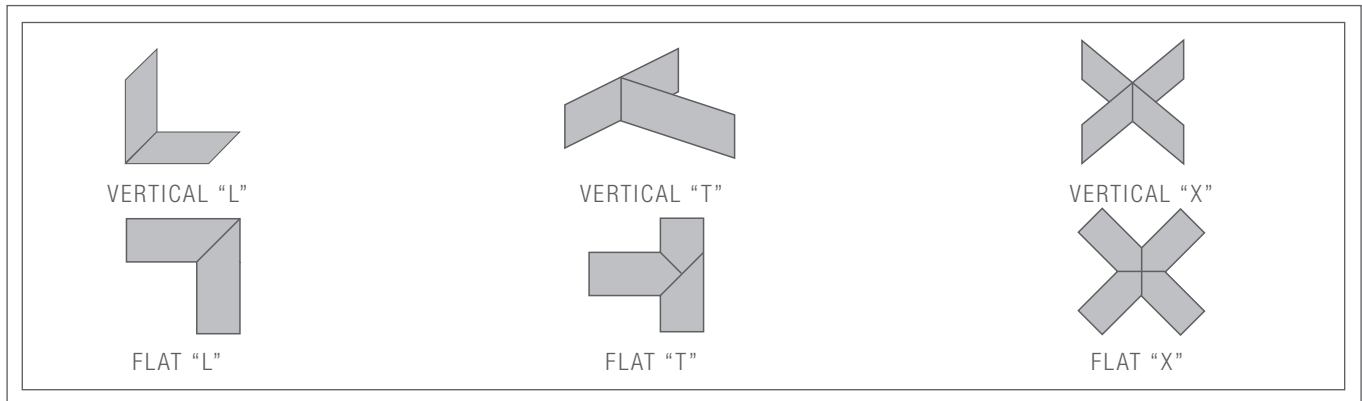

The information and the recommendations relating to the application and end use of this product are given in good faith and are based on the information provided by the manufacturer of the product and / or the Company's current knowledge and experience in connection with the product when properly stored, handled and applied under normal conditions and no liability of final function at the job site is assumed. In practice, the differences in materials, substrates and actual site conditions are such that no warranty in respect of merchantability of or fitness for a particular purpose, nor any liability arising out of any legal relationship whatsoever, can be inferred either from this information, or from any written and / or oral recommendations, or from any other advice offered by the Company. No responsibility or liability by the Company will be accepted for misuse, misreading or derivation from the recommended guidelines in respect of this product and the user shall determine the suitability of the product for his intended use and assume all risks and liability in connection therewith. The information contained in this brochure may change at any time without notice.

Effective Date: 1 January 2014

CORKJOINT (MALAYSIA) SDN BHD 383102-H
No.51, Jalan BRP 8/2, Bukit Rahman Putra Industrial Park
47000, Sungai Buloh, Selangor Darul Ehsan, Malaysia
Tel +603 6148 8010
Fax +603 6148 8020

CORKJOINT (SINGAPORE) PTE LTD 200716724-K
10, Admiralty Street, #03-82 North Link Building
Singapore 757695
Tel +65 6455 9331
Fax +65 6455 8535